

Ultra compact and efficient 2-stage filter in ECO design for 3-phase systems



### Description

- High attenuation value
- Cost optimized filter design with excellent price / performance ratio
- Very light due to partial potting

### Standards

- IEC 60939
- UL 1283, Edition 5, CSA 22.2 No. 8-M1986, @ Ta 40 °C

### Approvals

- VDE Certificate Number: 40023521
- UL File Number: E72928

### Applications

- Voltage rating 480 VAC for world wide acceptance
- Especially designed for industrial applications such as: Frequency Converters, Stepper Motor Drives, UPS-Systems, Inverters
- Qualified for use in equipment according IEC/EN 60950

### References

#### Weblinks

[pdf](#), [html](#), [General Product Information](#), [Approvals](#), [RoHS](#), [CHINA-RoHS](#), [e-Store](#), [SCHURTER-Stock-Check](#), [Distributor-Stock-Check](#)

### Technical Data

Rated Current	10 - 115A
Rated voltage	480VAC, 50/60 Hz
Approval for	10 - 115A @ Ta 40 °C / 480VAC; 50/60Hz
Overload Current	1.5 x Ir
Leakage Current	industrial < 5 mA (440V / 50Hz)
Dielectric Strength for 480 VAC	> 2.25kVDC between L-L > 3kVDC between L-PE
Number of Filter Stages	2
Weight	1.1 - 5 kg
Material: Housing	Aluminum
Sealing Compound	UL 94V-0

Mounting	Screw-on mounting on chassis, upright or lengthwise
Terminal	Bolts and nuts
Operating Temperature [°C]	-25 °C to 100 °C
Climatic Category	25/100/21 acc. to IEC 60068-1
Degree of Protection	IP 20 acc. to IEC 60529
Protection Class	Suitable for appliances with protection class 1 acc. to IEC 61140
MTBF	> 200'000h acc. to MIL-HB-217 F

## Dimensions

Case 94

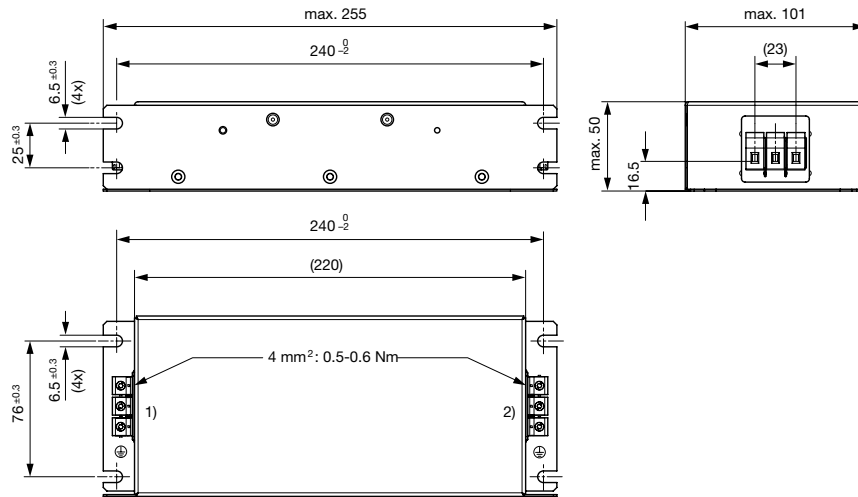

1) Line  
2) Load  
Case 95

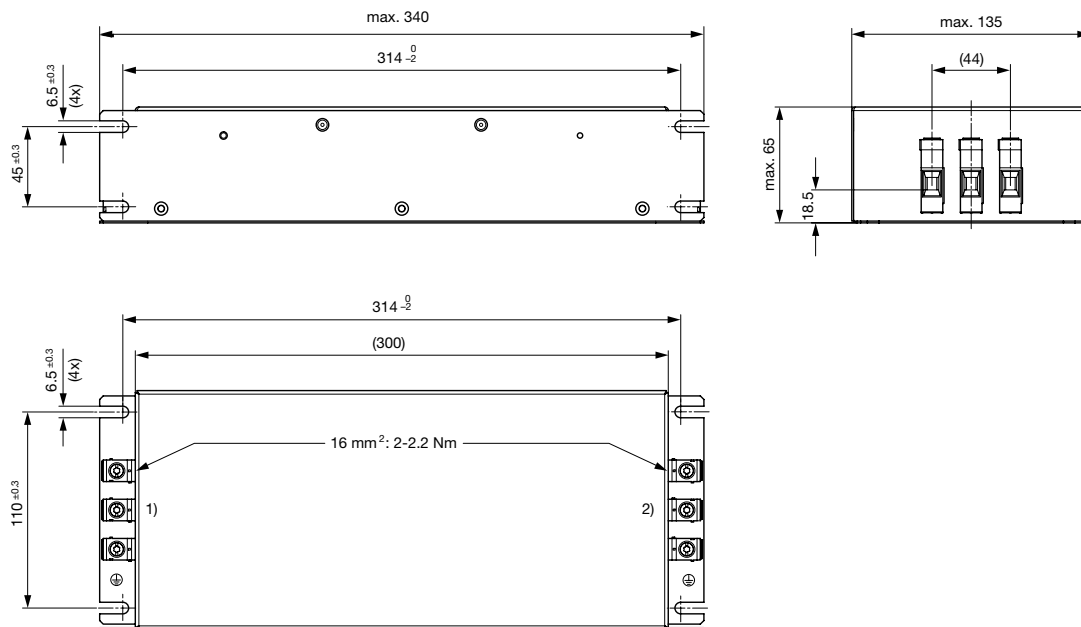

1) Line  
2) Load

Case 96

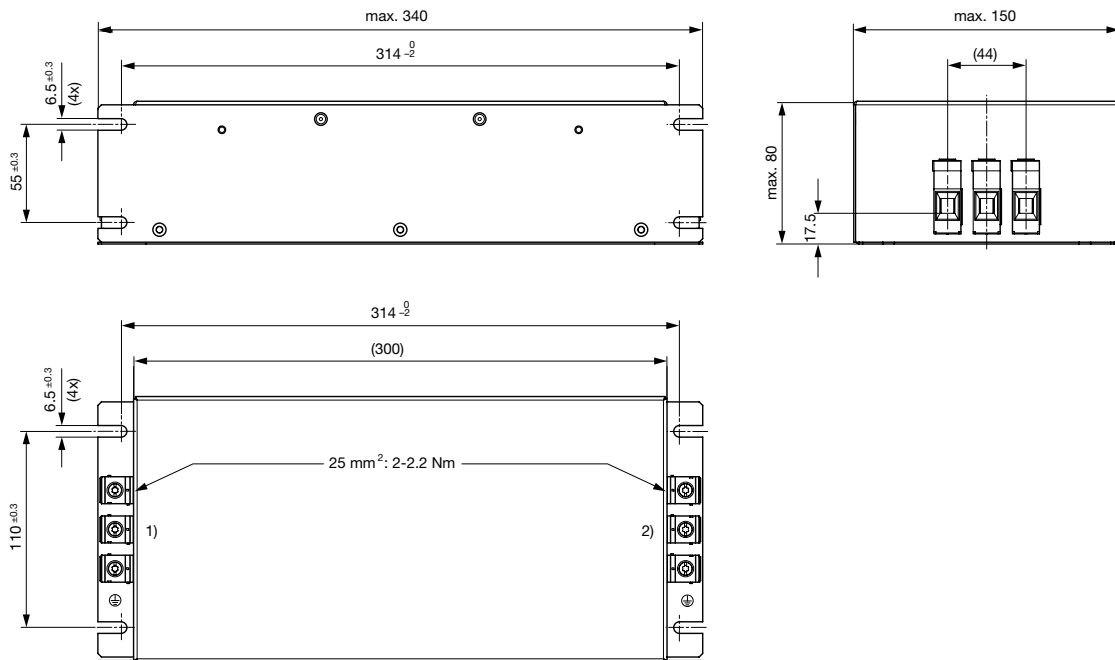

- 1) Line
- 2) Load

Case 97

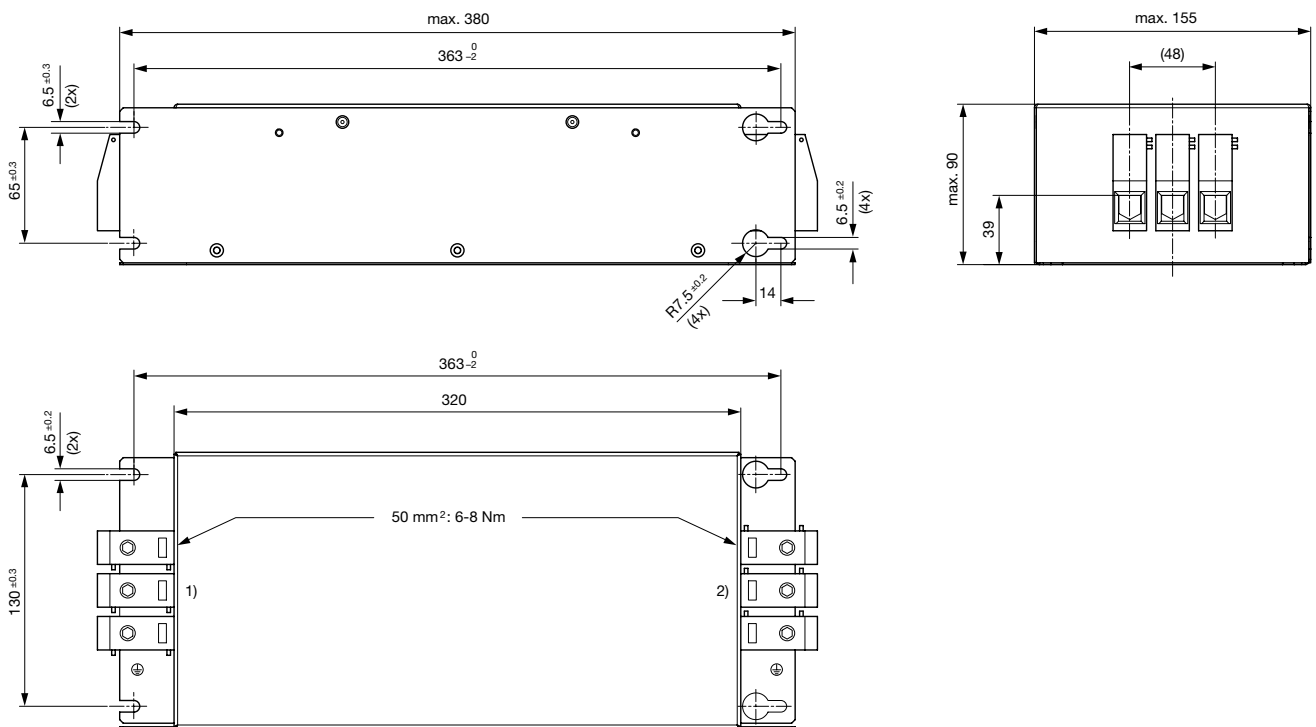

- 1) Line
- 2) Load

### Technical data to the filter components

Rated Current [A]	L [mH]	C1 [μF]	C2 [μF]	C3 [μF]	C4 [nF]	R1 [MΩ]	R2 [MΩ]	Netzfilter Aus-
10	2.3	1	1	1	10	1	1	Indus-
20	1.5	1	1	1	10	1	1	Indus-
36	0.9	1	1	2.2	47	1	2.2	Indus-
50	0.45	1	1	2.2	47	1	2.2	Indus-
66	0.45	1	1	2.2	47	1	2.2	Indus-
80	0.32	1	1	2.2	47	1	2.2	Indus-
115	0.24	1	2.2	2.2	100	1	2.2	Indus-

### Diagrams

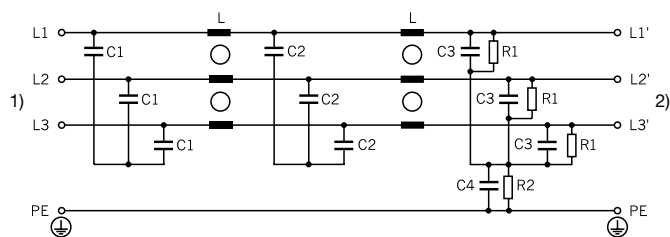

- 1) Line
- 2) Load

### Attenuation Loss

--- differential mode    \_\_\_\_ common mode

Industrial Version

10A (FMBC-0994-1000)

20A (FMBC-0994-2000)

36A (FMBC-0995-3600)

50A (FMBC-0996-5000)

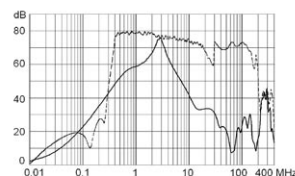
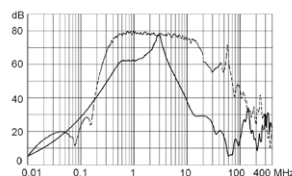
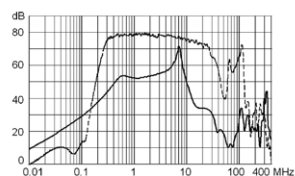
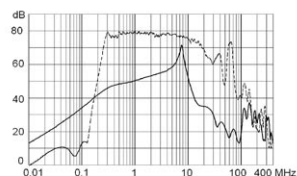

66A (FMBC-0996-6600)

80A (FMBC-0996-8000)

115A (FMBC-0997-H115)

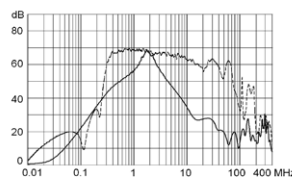
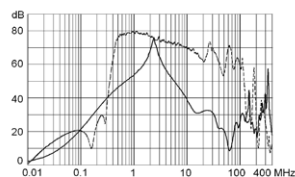
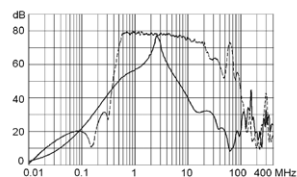

### Variants

Rated Current [A]	Tripped Power Dissipation [W]	Contact Resistance [mΩ]	Leakage Current [mA] <sup>1)</sup>	Weight [kg]	Screw clamps	Housing	Packaging unit [PCS]	Order Number
10	4	37	5	1.1	10	94	1	FMBC-0994-1000
20	9	20	5	1.6	10	94	1	FMBC-0994-2000
36	5	3.5	7.5	2.2	16	95	1	FMBC-0995-3600
50	20	7.5	7.5	2.7	16	95	1	FMBC-0995-5000
66	22	4.5	7.5	3.4	25	96	1	FMBC-0996-6600
80	24	3.5	7.5	3.4	25	96	1	FMBC-0996-8000
115	36	2.5	15.0	5	35	97	1	FMBC-0997-H115

1) Worst case leakage current acc. to IEC60950 - Annex G4 (situation with two interrupted lines). Nominal leakage current acc. to IEC60950 - 5.2.5. can be found in section technical data.

2) Maximum conductor cross section (wire gauge) to be used; a comparative table for AWG and mm<sup>2</sup> values can be found in the general product information www.schurter.com/emc\_info

---

**Packaging unit**      1 Pcs

---