

Solenoid operated spool valve

Flange construction

- ◆ 4/2-way impulse execution, detented
- ◆ 4/3-way with spring centered mid position
- ◆ 4/2-way with spring reset
- ◆ $Q_{max} = 30 \text{ l/min}$
- ◆ $p_{max} = 350 \text{ bar}$

NG6

ISO 4401-03

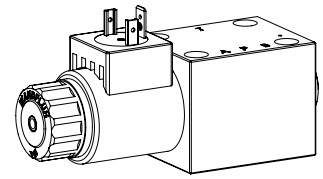

DESCRIPTION

Direct operated solenoid spool valve with 4 connections in 5 chamber design. Spool detented or with spring reset. With the solenoids deenergised, the spool is held in the center position by the spring (4/3), or switched back to the offset position (4/2). With the impulse spool (4/2), the spool is held in the switching position by the detent. Precise spool fit, low leakage, long service life time. Spool made from hardened steel, valve body from high quality hydraulic cast steel. Wide range of standard and special voltages.

APPLICATION

Spool valves are mainly used for controlling direction of movement and stopping of hydraulic cylinders and motors. The direction of movement is determined by the position of the spool and its symbol. Switching performance and leakage of the valves must be taken into account when designing the system. Solenoid spool valves are suitable for machine tools and handling systems of any kind.

SYMBOL

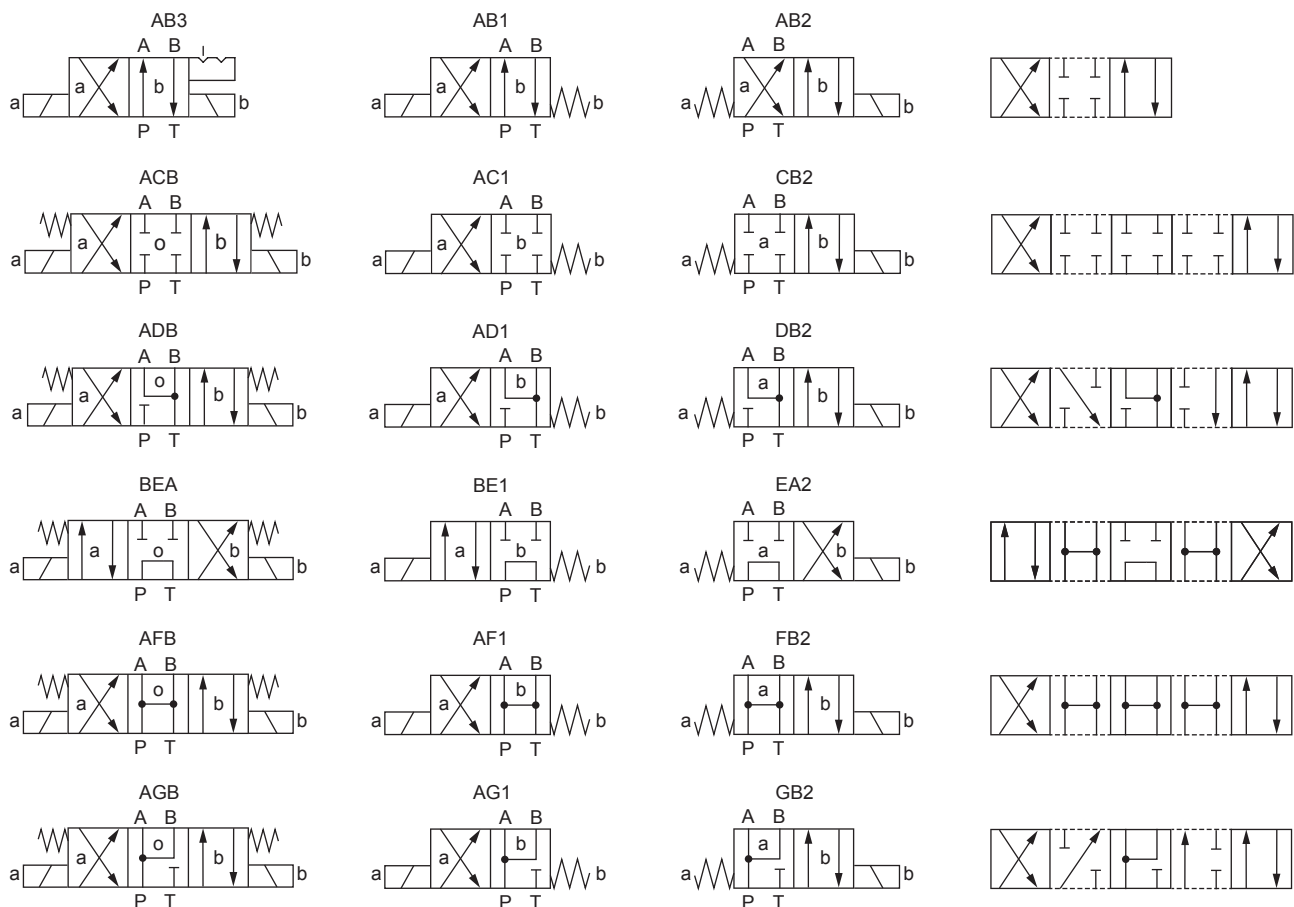

TYPE CODE

Spool valve, direct operated		W D		F A06	-		-		/		-		Z546 #	
Slip-on coil Economy			<input type="checkbox"/>											
Slip-on coil Medium			<input type="checkbox"/>											
Flange construction														
International standard interface ISO, NG6														
Designation of symbols acc. to table														
Spool specification	Standard		<input type="checkbox"/>											
	Low Leakage		<input type="checkbox"/>	1/x	(only Economy)									
Nominal voltage U_N	12 VDC		<input type="checkbox"/>	G12		115 VAC		<input type="checkbox"/>	R115					
	24 VDC		<input type="checkbox"/>	G24		230 VAC		<input type="checkbox"/>	R230					
	without coil		<input type="checkbox"/>	X5										
Slip-on coil	Metal housing round with one-sided collar		<input type="checkbox"/>	V										
	Metal housing square with one-sided collar		<input type="checkbox"/>	N	(only Medium)									
Connection execution	Connector socket EN 175301-803 / ISO 4400		<input type="checkbox"/>	D										
	Connector socket AMP Junior-Timer		<input type="checkbox"/>	J	(only for $U_N \leq 75$ VDC)									
	Connector Deutsch DT04 - 2P		<input type="checkbox"/>	G	(only for $U_N \leq 75$ VDC)									
Sealing material	NBR		<input type="checkbox"/>											
	FKM (Viton)		<input type="checkbox"/>	D1										
Manual override	integrated		<input type="checkbox"/>											
	push-button		<input type="checkbox"/>	HF1										
	spindle		<input type="checkbox"/>	HS1										
Execution														
Design index (subject to change)														

1.2.-58

GENERAL SPECIFICATIONS

Designation	4/2-, 4/3-spool valve
Construction	Direct operated
Mounting	Flange construction
Nominal size	NG6 according to ISO 4401-03
Actuation	Switching solenoid
Ambient temperature	-25...+70 °C (NBR) -20...+70 °C (FKM) if > +50 °C, then no undervoltage is admissible
Weight	1,10 kg (1 solenoid Economy) 1,16 kg (1 solenoid Medium) 1,35 kg (2 solenoids Economy) 1,47 kg (2 solenoids Medium)
MTTFd	150 years

ACTUATION

Actuation	Switching solenoid, wet pin push type, pressure tight
Execution	Economy: V.E37 / 19 x 40 (Data sheet 1.1-168) Medium: V.E37 / 19 x 50 (Data sheet 1.1-168) N.S35 / 19 x 50 (Data sheet 1.1-175)
Connection	Connector socket EN 175301 – 803 Connector socket AMP Junior-Timer Connector Deutsch DT04 – 2P

ELECTRICAL SPECIFICATIONS

Protection class	Connection execution D: IP65 Connection execution J: IP66 Connection execution G: IP67 and IP69K
Relative duty factor	100 % DF
Switching frequency	15'000 / h
Service life time	10 ⁷ (number of switching cycles, theoretically)
Voltage tolerance	± 10 % with regard to nominal voltage
Standard nominal voltage	12 VDC, 24VDC, 115 VAC, 230 VAC AC = 50 to 60 Hz, rectifier integrated in the connector socket

Note! Other electrical specifications see data sheet 1.1-168 (slip-on coil V) and 1.1-175 (slip-on coil N)



HYDRAULIC SPECIFICATIONS

Working pressure	$p_{max} = 350 \text{ bar}$ ($P_T < 20 \text{ bar}$) $p_{max} = 315 \text{ bar}$ ($P_T > 20 \text{ bar}$)
Tank pressure	$p_{Tmax} = 100 \text{ bar}$
Maximum volume flow	$Q_{max} = 30 \text{ l/min}$, see characteristics
Leakage oil	See characteristics
Fluid	Mineral oil, other fluid on request
Viscosity range	12 mm ² /s...320 mm ² /s
Temperature range fluid	-20...+70 °C
Contamination efficiency	Class 20 / 18 / 14
Filtration	Required filtration grade $\beta_{10...16} \geq 75$, see data sheet 1.0-50

SURFACE TREATMENT

- ◆ The valve body is painted with a two component paint
- ◆ The armature tube, the slip-on coil and the plug screw are zinc-nickel coated

SEALING MATERIAL

NBR or FKM (Viton) as standard, choice in the type code

PERFORMANCE SPECIFICATIONS

Oil viscosity $\nu = 30 \text{ mm}^2/\text{s}$

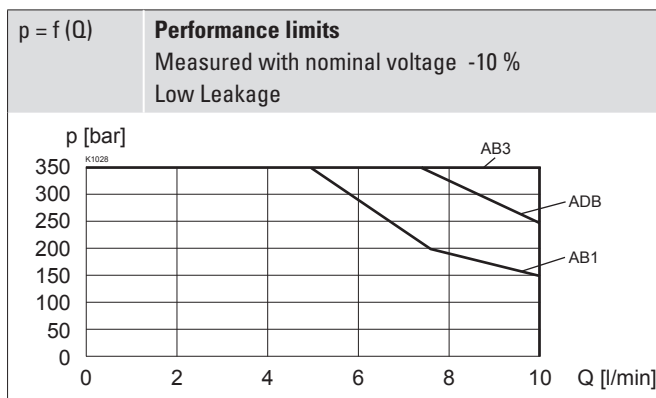
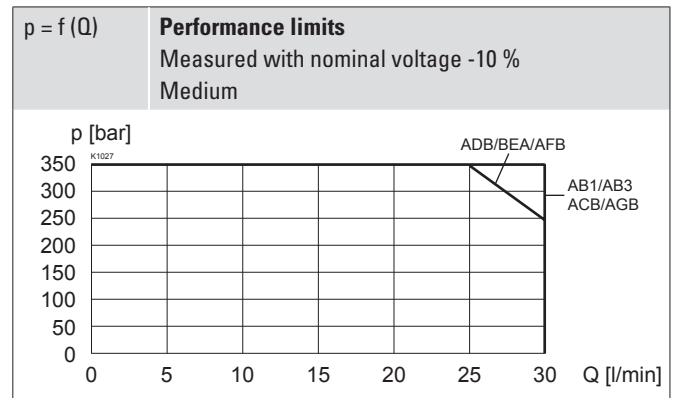
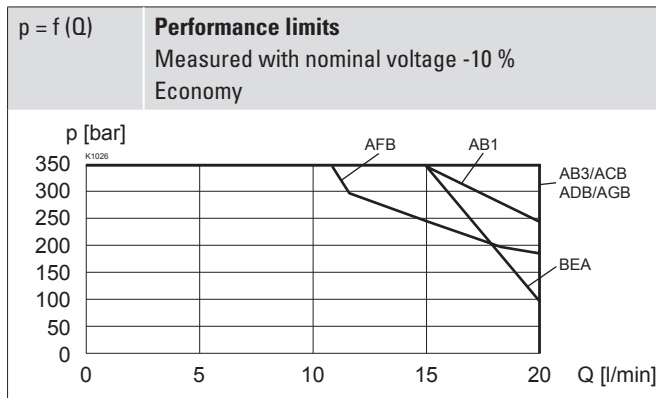

PERFORMANCE SPECIFICATIONS

Oil viscosity $\nu = 30 \text{ mm}^2/\text{s}$

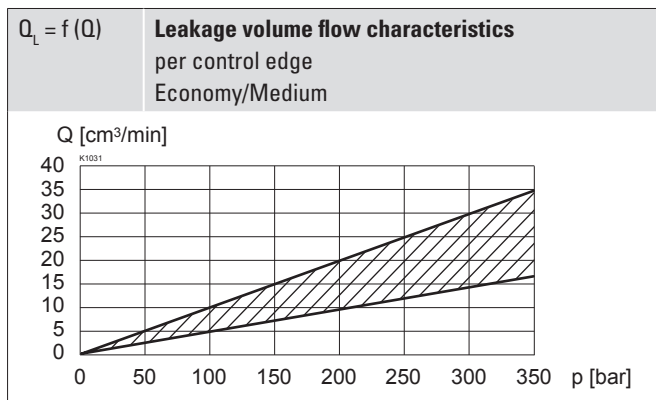
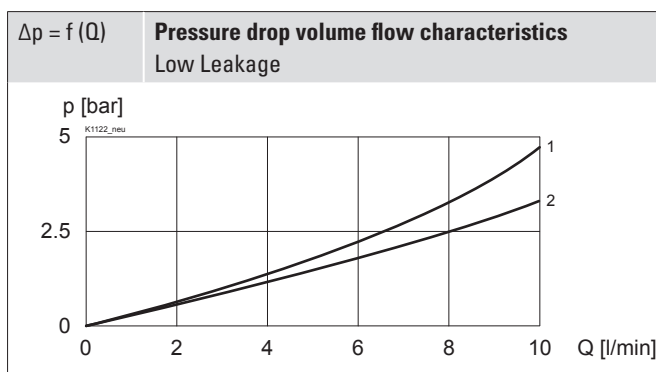
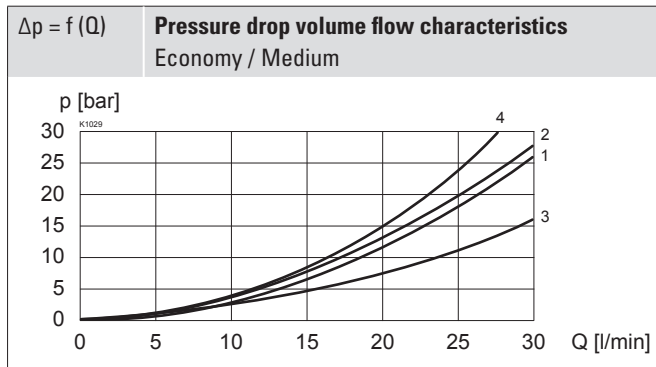

Symbol	Volume flow direction				
	P - A	P - B	P - T	A - T	B - T
AB1	2	2	-	1	1
AB3	2	2	-	1	1
ACB	2	2	-	1	1
ADB	2	2	-	1	1
BEA	1	1	4	1	1
AFB	1	1	3	1	1
AGB	1	1	-	1	1

Symbol	Volume flow direction				
	P - A	P - B	P - T	A - T	B - T
AB1	1	1	-	1	1
AB3	1	1	-	1	1
ADB	1	1	-	2	2

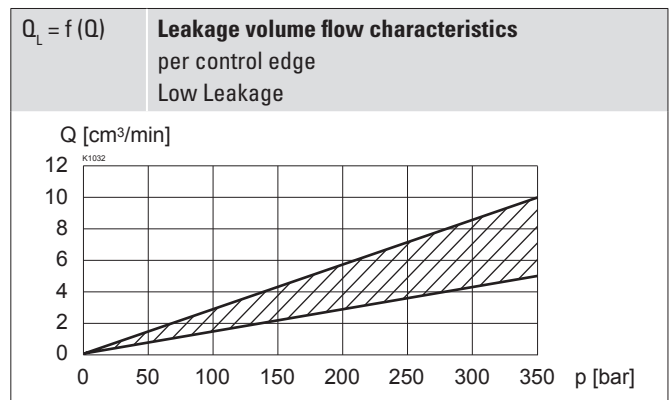

STANDARDS

Mounting interface	ISO 4401-03
Solenoids	DIN VDE 0580
Connection execution D	EN 175301 – 803
Protection class	EN 60 529
Contamination efficiency	ISO 4406

INSTALLATION NOTES

Mounting type	Flange mounting 4 fixing holes for socket head screws M5 x 45
Mounting position	Any, preferably horizontal
Tightening torque	Fixing screws $M_D = 5,2 \text{ Nm}$ (screw quality 8.8, zinc coated) $M_D = 5 \text{ Nm}$ knurled nut

Note!



The length of the fixing screw depends on the base material of the connection element.

DIMENSIONS

4/3-way valve (spring centred)

4/2-way valve (impulse)

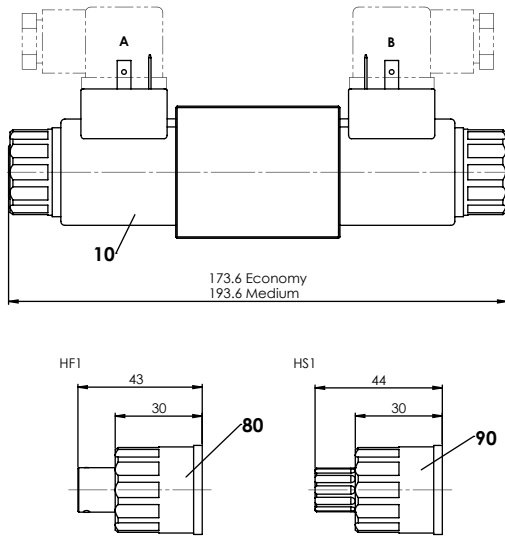

4/2-way valve (spring reset)

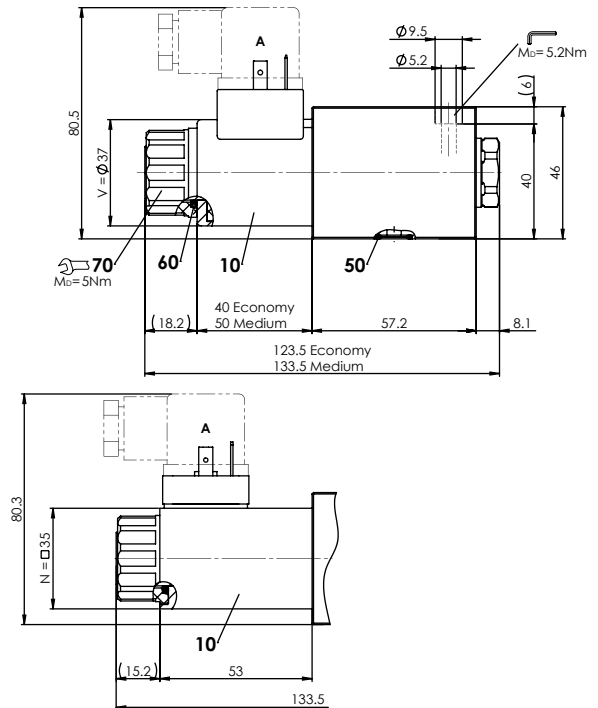

HYDRAULIC CONNECTION

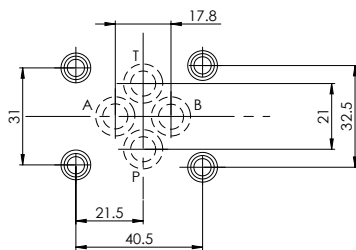

MANUAL OVERRIDE

- ◆ Integrated (-) Actuation pin integrated in the armature tube. Actuation by pressing the pin
- ◆ Push-button (HF1) Integrated in the knurled nut. Actuation by pressing the push-button
- ◆ Spindle (HS1) Integrated in the knurled nut. Actuation by turning the spindle (continuously variable valve actuation)

Attention! The actuation of the manual override is possible up to a tank pressure of:

- 40 bar Integrated (-)
- 40 bar Push-button (HF1)
- 100 bar Spindle (HS1)



PARTS LIST

Position	Article	Description
10	206.2...	V.E37 / 19 x 40
		V.E37 / 19 x 50
	260.5...	N.S35 / 19 x 50
50	160.2093	O-ring ID 9,25 x 1,78 (NBR)
	160.6092	O-ring ID 9,25 x 1,78 (FKM)
60	160.2187	O-ring ID 18,72 x 2,62 (NBR)
	160.6187	O-ring ID 18,72 x 2,62 (FKM)
70	154.2700	Knurled nut
80	253.7001	Push-button
90	253.7000	Spindle

ACCESSORIES

Mating connector grey (A)	Article no. 219.2001
Mating connector black (B)	Article no. 219.2002
Mounting screws	Data sheet 1.0-60
Threaded subplates	Data sheet 2.9-30
Multi-station subplates	Data sheet 2.9-60
Horizontal mounting blocks	Data sheet 2.9-100
Technical explanations	Data sheet 1.0-100
Hydraulic fluids	Data sheet 1.0-50
Filtration	Data sheet 1.0-50
Relative duty factor	Data sheet 1.1-430