



EL640.400-C2, -C3 and -CD3
640 x 400 Pixel Displays

USER'S MANUAL

www.planar.com

Revision Control

Date	Description
January 1998	Document number P002194 Ver 5
June 2004	Document number 020-0355-00A

Contents

Product Profile	3
EL Technology.....	3
Electrical Characteristics.....	4
Connector Layout	4
Input to the Display.....	5
Control Basics	6
Power Input.....	6
Connectors	6
Signal Inputs	6
Jumper Description.....	7
Input Specifications.....	7
Display Features	8
Display Operation Modes.....	8
Supported Timing Modes	9
Display Enable	9
200 Rows Mode.....	10
Two Bit Parallel Data	10
Brightness Control	10
Self Test.....	10
Installation and Handling.....	11
Video Input Timing.....	12
Setup and Hold Timing	15
Operational Specifications	16
Environmental.....	16
Reliability.....	16
EMC	16
Safety.....	16
Optical.....	17
<i>Display Colour</i>	17
<i>Optional Filter</i>	17
Mechanical Characteristics	18
Display External Dimensions.....	18
Display Viewing Area Characteristics.....	18
Description of Warranty	22
Easy to Use	22
Support and Service.....	23
Ordering Information	23

Figures

Figure 1. EL Technology.....	3
Figure 2. Connector Layout.....	4
Figure 3. Video Input Timing - 350 Row VGA Modes	12
Figure 4. Video Input Timing - 400 Row VGA Modes	13
Figure 5. 640 columns x 400 rows (Normal mode).....	14
Figure 6. Setup and Hold Timing.....	15
Figure 7. Viewing Area Characteristics	19
Figure 8. EL640.400-C2, -C3 and CD3 Back and Side Views	20
Figure 9. EL640.400-C2 FRA, -C3 FRA and CD3 FRA Back and Side Views.....	21

Tables

Table 1. Input to the Display	5
Table 2. Connectors.....	6
Table 3. PS1	7
Table 4. Input Specifications	7
Table 5. Supported Timing Modes.....	9
Table 6. Video Input Timing - 350 Row VGA Modes	12
Table 7. Video Input Timing - 400 Row VGA Modes	13
Table 8. Video Input Timing - 640 columns x 400 rows.....	14
Table 9. Setup and Hold Timing.....	15
Table 10. Environmental Characteristics	16
Table 11. Optical Characteristics.....	17
Table 12. Display External Dimensions.....	18
Table 13. Display Viewing Area Characteristics.....	18

Product Profile

The EL640.400-C2, -C3 and -CD3 displays are VGA compatible high-resolution electroluminescent (TFEL) flat panel displays. They replace the bulky CRT in control and instrument product designs. They feature an intergrated DC/DC converter, and their compact dimensions save space that can allow addition of features or reduction in overall size. The two displays are mechanically identical.

The EL640.400-C2, -C3 and -CD3 are timing compatible with Planar EL640.400-CB series displays and signal compatible with VGA Feature Connector supporting the 350 and 400 line standard VGA modes. They may be driven at frame rates up to 80Hz.

The displays require +5 Vdc and +11...+30 Vdc power input and four to five basic input signals to operate:

1. Video Data or pixel information
2. Video Clock, pixel clock, or dot clock
3. Horizontal Sync
4. Vertical Sync
5. Blanking in VGA timing modes

EL Technology

A display consists of an electroluminescent glass panel and a mounted circuit board with control electronics.

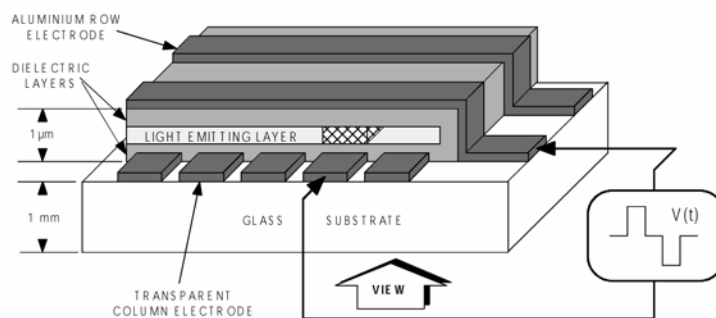

Figure 1. EL Technology.

The EL glass panel is a solid-state device with a thin film luminescent layer sandwiched between transparent dielectric layers and a matrix of row and column electrodes. The row electrodes, in back, are aluminum; the column electrodes, in front, are transparent. The entire thin film device is deposited on a single glass substrate. The glass panel is mounted to an electronic circuit assembly board (ECA) with an elastic spacer. The ECA is connected to the EL glass panel with soldered lead frames. The result is a flat, compact, reliable and rugged display device.

The EL640.400-CD3 display includes a light absorbing ICE (Integrated Contrast Enhancement) construction of the display glass. ICE background significantly improves the luminance contrast of the display in bright ambients. The ICE also removes the halo around the lit pixels in dark ambient making the appearance of each pixel extremely crisp and clear.

In the EL640.400-C2, -C3 and -CD3 , the 640 column electrodes and 400 row electrodes are arranged in an X-Y formation with the intersecting areas performing as pixels. Voltage is applied to both the correct row electrode and the correct column electrode to cause a lit pixel. Operating voltages required are provided by an integral DC/DC converter.

Electrical Characteristics

Connector Layout

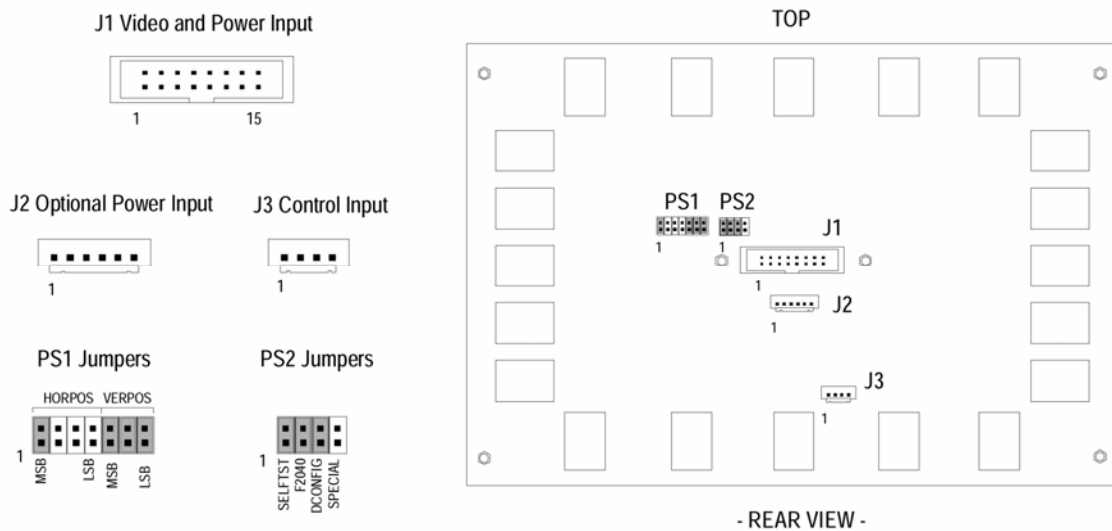

Fig 2. Input Connectors and Jumpers and their location.

Input to the Display

Table 1. Input to the Display.

Pins	Signal	Symbol	Description
J1(Data/power input connector)			
1, 2	Voltage	Vcc2	Supply voltage (+11...+30 V) converted to required internal high voltages (see J2).
3, 4	Voltage	Vcc1	Supply voltage (+5 V) for the logic (see J2).
5	Blanking	_BLANK	Used in VGA and SPECIAL modes. In NORMAL mode should be high or left disconnected.
6,8,10 12,14,16	Ground	GND	Signal return.
7	Two-bit data	TVID	Second data input for two bit parallel mode. The TVID input is for odd columns and the VID for even ones.
9	Vertical Sync	VS	The vertical sync signal VS controls the vertical position of the picture.
11	Horizontal Sync	HS	The horizontal sync signal HS controls the internal row counter and in the NORMAL mode the horizontal position of the picture.
13	Video Clock	VCLK	The VCLK signal shifts data present on the VID and TVID lines into the display system. VCLK is active on the rising edge.
15	Video Data	VID	Signal that supplies the pixel information to the system.
J2 (Optional power input connector)			
1	Voltage	Vcc2	Same as J1, Pins 1, 2 (not necessary to connect if power is supplied via J1).
2, 3	Ground	GND	Same as J1 Pins 6, 8, 10, 12, 14, 16 (not necessary to connect if power is supplied via J1).
4	Voltage	Vcc1	Same as J1 Pins 3, 4 (not necessary to connect if power is supplied via J1).
5	Low Power	_LOWPWR	The power consumption of the display is lowered to LOW-POWER-OPERATION values if the _LOWPWR is low, internally pulled high if left disconnected.
6	Enable	ENABLE	The operation of the display unit is disabled if the ENABLE input is low, internally pulled high (enable) if left disconnected.
J3 (Optional control input connector)			
1	Luminance Pot.1	LUMPOT1	The inputs for an external logarithmic 50kΩ potentiometer to adjust the luminance of the display. Can be left disconnected. The luminance is then at the maximum level.
2	Luminance Pot.2	LUMPOT2	
3	Reserved		Reserved for future use.
4	Reserved		Reserved for future use.

Control basics

The EL panel has 640 transparent column electrodes crossing 400 row electrodes in an X-Y fashion. Light is emitted when an AC voltage is applied at a row-column intersection. The display operation is based on the symmetric, line at a time data addressing scheme which is synchronized by the external VS, HS, and VCLK input signals. The internal control signals and the high voltage pulses for the column and row drivers are generated internally by the control electronics. All control signal inputs are HCT compatible with 100 Ω series resistor.

Power Input

The required supply voltages for the display are +5 Vdc (Vcc1) for the logic and +11...+30 Vdc input (Vcc2) for the integrated DC/DC converter. The high voltages needed for driving the display are generated by the DC/DC converter from the Vcc2 input voltage. The input voltages can be connected either through J1 or J2.

Connectors

Table 2. Connectors.

J1	16-pin header Mating Locking clip	ODU 511.066.003.016 or eq. ODU 517.065.003.016 or eq. ODU 517.065.716.700 or eq.
J2	6-pin header Mating Protector	Hirose DF1-6P-2.5DSA or eq. Hirose DF1-6S-2.5 R 24 or eq. Hirose DF1-6A 1.33
J3	4-pin header Mating Protector	Hirose DF1-4P-2.5DSA or eq. Hirose DF1-4S-2.5 R 28 or eq. Hirose DF1-6A 1.33

Signal Inputs

For easy interfacing with VGA display controllers the video input signals are VGA Feature Connector compatible. The display automatically determines the mode of operation. Connector J2 contains two control inputs. LOWPWR input is used to minimize the power consumption of the display and ENABLE input is used to shut off the display when it is not accessed (screen saver function). If the ENABLE or _LOWPWR functions are not in use and the power is connected via J1, the connector J2 can be left disconnected.

Connector J3 contains input for external luminance control it can be left disconnected if its function is not needed.

Jumper Description

PS1

The horizontal and vertical positioning of the image can be adjusted with jumpers on pinstrip PS1. VERPOS0...VERPOS2 (MSB) are for vertical positioning and HORPOS0...HORPOS3 (MSB) are for horizontal positioning. Both settings form a binary number where a set jumper is a "0" and open jumper a "1". The adjustment range for VERPOS is 0 to 7 upwards (default 000 for no shift) and HORPOS 7 right (0000) to 8 left (1111) (default 0111 for no shift).

Table 3. PS2.

Position Name	Function
1 SELFTST	Self test function is selected, if theSELFTEST jumper is OFF. In self test, the input video data at VID and TVID inputs are displayed asynchronously without any other input signals.
2 F2040	200 lines mode. All data is repeated in two consecutive rows. Normally should be installed
3 DCONFIG	The Two-bits-parallel mode is selected if this jumper is OFF (see page 10.)
4 reserved	Reserved, do not insert jumper.

When shipped from the factory, jumpers PS2/1, 2 and 3 are set.

Input Specifications

Table 4. Input Specifications.

Parameter	Symbol	Min.	Typ.	Max.	Absolute max. rating
Logic input HIGH		2 V			Vcc1 + 0.5V
Logic input LOW				0.8 V	-0.5 V
Logic supply voltage	Vcc1	4.75	5.0 V	5.25	6 V
Logic supply current at 5 V	Icc1	V	—	V	
	Vcc2	—	—	0.2 A	33 V
Display Supply voltage	Icc2	11 V	0.8 A	30 V	
Supply current at 12 V	Icc2		0.5 A	1.6 A	
Supply current at 12 V (LOWPWR)			11 W	1.0 A	
Power consumption 5V/12V			7 W	20 W	
Power consumption 5V/12V (LOWPWR)				13 W	

Operating conditions: Frame rate 70 Hz. ambient temperature 25°C.

Note: Absolute maximum ratings are those values beyond which damage to the device may occur. The minimum and maximum specifications in this Operations Manual should be met, without exception, to ensure the long-term reliability of the display. Planar does not recommend operation of the display outside these specifications.

Display Features

Display Operation Modes

EL640.400-C2, -C3 and -CD3 have two input timing modes. VGA Mode supports standard 200, 350 and 400 row VGA modes and Normal Mode is similar to Normal Mode in most Planar displays. Timing mode is determined from combination of the polarities of the VS and HS pulses and the _BLANK signal at the rising edge of the VS pulse and the polarities of VS and HS pulses at the rising edge of the _BLANK pulse.

In VGA modes, the number of columns is determined by the number of VCLK pulses during a HS pulse. Atolerance of ± 1 pulse is accepted.

VGA Modes: The display data and control input is compatible with feature connector signals from VGA board. The display supports VGA modes 0, 1, 2, 3, 0*, 1*, 2*, 3*, 0+, 1+, 2+, 3+, 4, 5, 6, 7, 7+, D, E, F, 10 and 13. It notifies the polarity of the HS and VS at the rising edge of BLANK and determines the number of rows in the mode. **Note that in VGA modes 0, 1, 0*, 1*, 0+, 1+, 4, 5, D and 13, where the software uses 320 or 360 columns, the size of borders varies from one VGA-controller to another. Therefore the image may not be centered properly using those modes.**

The image is centred automatically, and in text modes with 720 pixels horizontally, every ninth pixel is omitted for compatibility. The non-displayed pixel is in the space region of the character matrix, and therefore no information is lost. The borders are normally eliminated because of the centering. The upper and lower borders are however displayed in the modes using 350 rows due to extra rows not needed for the picture.

The 480 row VGA modes are not supported. Even if the display does not scan in these modes (11, 12), it continues to operate with no failures when a supported mode is detected.

Normal Mode is pin and timing compatible with MD640.400 Series displays and the Normal mode of EL640.400-CB series displays. In this mode only four input signals are needed: video data (VID), video clock (VCLK), horizontal synchronizing (HS) and vertical synchronizing (VS). _BLANK is not in use and should be pulled high or left disconnected.

In Normal mode the last 640 pixels before the fall of the HS are displayed. The topmost row displayed is the first HS HIGH time ending after HS Hold from VS time (T3 in Normal Mode) from the rising edge of VS. If HS is running continuously, the rising edge of the VS can be simultaneous to the previous falling or rising edge of the HS.

See details on the different timing modes as well as setup and hold timing on page 12-15.

Support Timing Modes

Table 5. Supported Timing Modes.

VGA Mode	Type	Text format	Char. box	Vsync Freq. (Hz)	Pixels (software)	Double Scan	Border size	
							H	V
0, 1	text	40 x 25	8 x 8	70	320 x 200	Yes	0	7
2, 3	text	80 x 25	8 x 8	70	640 x 200	Yes	8	7
0*, 1*	text	40 x 25	8 x 14	70	320 x 350	No	0	6
2*, 3*	text	80 x 25	8 x 14	70	640 x 350	No	8	6
0+, 1+	text	40 x 25	9 x 16	70	360 x 400	No	0	7
2+, 3+	text	80 x 25	9 x 16	70	720 x 400	No	9	7
4, 5	graph	40 x 25	8 x 8	70	320 x 200	Yes	0	7
6	graph	80 x 25	8 x 8	70	640 x 200	Yes	8	7
7	text	80 x 25	9 x 14	70	720 x 350	No	9	6
7+	text	80 x 25	9 x 16	70	720 x 400	No	9	7
D	graph	40 x 25	8 x 8	70	320 x 200	Yes	0	7
E	graph	80 x 25	8 x 8	70	640 x 200	Yes	8	7
F	graph	80 x 25	8 x 14	70	640 x 350	No	8	6
10	graph	80 x 25	8 x 14	70	640 x 350	No	8	6
13	graph	40 x 25	8 x 8	70	320 x 200	Yes	0	7
Normal mode	graphics			72 max	640 x 400			

NOTES:

The top and right borders border values are used for image centering to the display matrix.

In VGA modes 0+, 1+, 2+, 3+, 7 and 7+ the character box is narrowed to 8 pixels by omitting the data of every 9th pixel.

In VGA modes 0, 1, 0*, 0+, 1+, 4, 5, D and 13, where the software uses 320 or 360 columns, the size of borders may vary from one VGA-controller card to another. The potentially needed picture adjustments may be done by programming the registers of the VGA controller chip.

Double Scan is a VGA card feature.

VGA modes 11 and 12 with 480 rows are not supported.

Display Enable

The display can be totally shut off for screen save or power reduction by a LOW state in the ENABLE control input. When disabled, the display stops scanning and only the DC/DC converter remains functional. The power consumption only appr. 2W. In normal operation the ENABLE input should be pulled HIGH or left disconnected (internal pull-up).

200 Rows Mode

200 Input data rows may be displayed using 400 rows by automatically doubling every data row to two consecutive display rows. This function is selected by removing jumper PS2/2 (F2040). The _BLANK input must also be in LOW state. For more information of this mode contact Planar.

Two Bit Parallel Data

To reduce the input data frequency in NORMAL mode the Video data can be input two bits per clock cycle. The two data inputs are organized so that the data for the odd columns, numbered from left to the right at the viewers side, is input at the TVID (J1/ pin 7) and the data for the even columns at VID (J1/ pin 15). The two bit parallel mode is selected by removing jumper 3 of the pin strip PS2.

Brightness Control

The brightness of the display can be adjusted (appr. between 10 and 100%) by an external 50k Ω logarithmic potentiometer between the LUMPOT1 and LUMPOT 2 inputs (J3/pins 1 and 2). The control function is done by feeding a small DC current signal via the external potentiometer from LUMPOT1 (+5V reference voltage) to LUMPOT2. If the two inputs are left disconnected, the brightness is at its maximum level.

Self Test

The operation of the display can be easily checked without any external signals by the self test function.

Remove Jumper 1 in pinstrip PS2.
Connect power to the display.

All pixels of the display will be lit with the exception of the first half of the topmost row.

Installation and Handling

The product should be mounted using the M3 insert nuts on the ECA. Beside the four corner nuts it is recommended to use also the two center nuts in the mounting, if the vibration or shock stress is severe.

Before touching the display, necessary precaution must be taken to prevent application of static charges on the display from the operator or tools.

The display is made of glass material and should be handled with proper care. Do not drop the display or allow hard objects to strike its surface.

NOTE: For trouble-free data transfer a maximum cable length of 300 mm (12 in.) from data transmitter to display input connector is recommended. If longer cables up to 2m (80 in.) length are needed, a serial resistor of appr. 47 Ω could be placed at each of the four signal line outputs of the transmitter in order to lower signal reflections.

Electrostatic Caution: Planar display use CMOS and power MOS-FET devices. These components are electrostatic sensitive. Unpack, assemble and examine this assembly in a staticcontrolled area only. When shipping use packing materials designed for protection of electrostatic-sensitive components.

Warning: The product generates potentially dangerous voltages capable of causing personal injury (high voltage pulses up to 195 Vac). Do not touch the display electronics during operation!

Video Input Timing

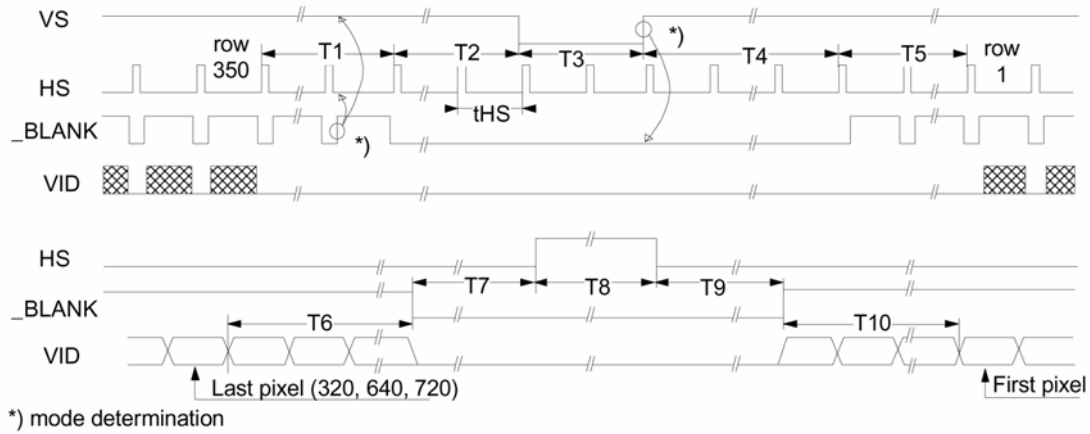
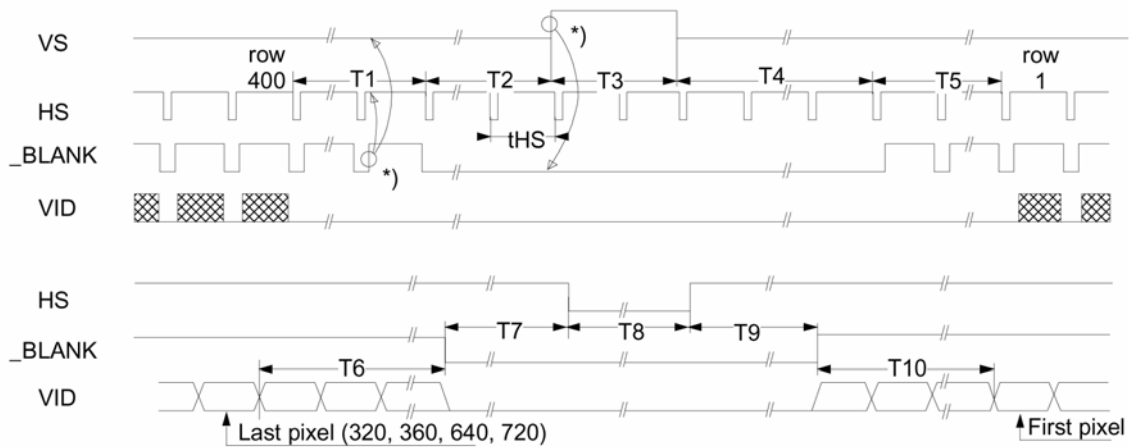

Fig 3. Video Input Timing, 350 Row VGA Modes

Table 6. Video Input Timing, 350 Row VGA Modes

Description				Unit
T1 Vertical Border	6			tHS
T2 Vertical Front Porch	31			tHS
T3 VS Pulse Width	2			tHS
T4 Vertical Back Porch	54			tHS
T5 Vertical Border	6			tHS
HS pulses / VS	449			
VS frequency	70			Hz
Description	320	640	720	Unit
T6 Horizontal Border	0	8	9	tVCLK
T7 Horizontal Front Porch	8	8	9	tVCLK
T8 HS Pulse Width	48	96	108	tVCLK
T9 Horizontal Back Porch	24	40	45	tVCLK
T10 Horizontal Border	0	8	9	tVCLK
VCLK pulses / HS	400	800	900	
HS period	31.8	31.8	31.8	μ s



*) mode determination

Fig 4. Video Input Timing, 400 Row VGA Modes

Table 7. Video Input Timing, 400 Row VGA Modes

Description					Unit
T1 Vertical Border	7				tHS
T2 Vertical Front Porch	5				tHS
T3 VS Pulse Width	2				tHS
T4 Vertical Back Porch	28				tHS
T5 Vertical Border	7				tHS
HS pulses / VS	449				
VS frequency	70				Hz
Description	320	360	640	720	Unit
T6 Horizontal Border	0	0	8	9	tVCLK
T7 Horizontal Front Porch	8	9	8	9	tVCLK
T8 HS Pulse Width	48	54	96	108	tVCLK
T9 Horizontal Back Porch	24	27	40	45	tVCLK
T10 Horizontal Border	0	0	8	9	tVCLK
VCLK pulses / HS	400	450	800	900	
HS period	31.8	31.8	31.8	31.8	μs

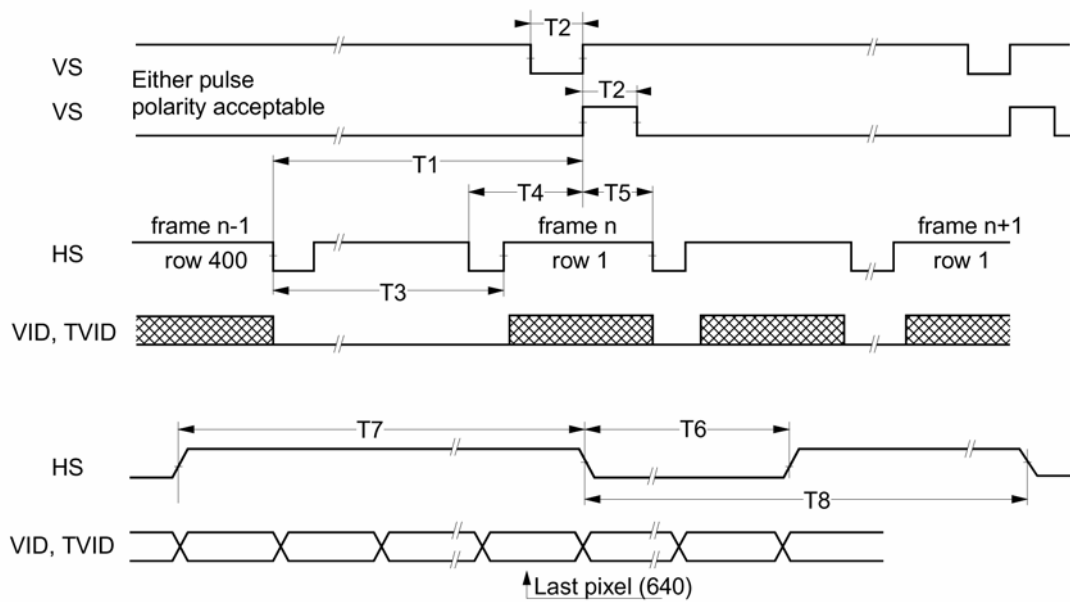

Fig 5. 640 columns x 400 rows (NORMAL mode)

Table 8. 640 columns x 400 rows (NORMAL mode)

Description	Min	typ	Max	Unit
T1 Vertical Front Porch ¹⁾	60			μ s
T2 VS HIGH/LOW time ²⁾	1			tVCLK
T3 Vertical Blank	40			μ s
VS frequency		70	80	Hz
Description	Min	Typ	Unit	
T4 HS setup to VS	9			tVCLK
T5 Vertical Back Porch	2			μ s
T6 HS Low Time ⁵⁾	4			tVCLK
T7 HS High Time ⁶⁾	640	640		tVCLK
T8 HS period	31			μ s

1) Needed to display the last row and to change the frame.

2) Only rising edge is used.

3) If vertical positioning is needed, please contact Planar.

4) If horizontal positioning is needed, please contact Planar.

5) Video Clock VCLK should be kept running.

6) The number of VCLK pulses during HS high time should be even.

Setup and Hold Timing

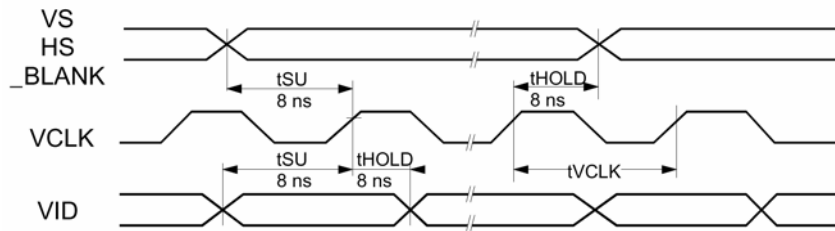

Figure 6. Setup and Hold Timing.

Table 9. Setup and Hold Timing.

Mode	tVCLK ns	fVCLK MHz
2+, 3+, 7, 7+	35.31	28.322
2, 3, 2*, 3*, 6, E, F, 10	39.71	25.175
0+, 1+	70.62	14.161
0, 1, 0*, 1*, 4, 5, D, 13	79.43	12.588
NORMAL	Min 33	Max 30

Operational Specifications

Environmental

Table 10. Environmental Characteristics.

Temperature		
Operating	C2	0...+55°C
	C3	-25...+65°C
Non-operating		-40...+85°C
Operating Survival	C2	-20...+65°C (no permanent damage)
	C3	-40...+65°C (no permanent damage)
Test duration 24 h at +65°C (without condensation)	C2	24 h at -20°C
	C3	24 h at -50°C
Humidity		
Relative Humidity		+40°C, 93% RH, Operating (IEC 68-2-3)
Damp Heat		+25...+55°C, 95% RH, Non operating (IEC 68-2-30)
Altitude		
Operating		15,000 m (50,000 ft.) above sea level
Vibration		
		20...500 Hz
		ASD level 0.05 g ² /Hz
		Random vibration wide band
		IEC 68-2-36, Test Fdb
Shock		
Magnitude		100 g
Duration		4 ms (half sine wave)
Number of shocks		18 (3 on each of the 6 surfaces)
		IEC 68-2-27, test Ea

Reliability

MTBF > 50,000 h @ 25°C

EMC

The display will not inhibit the end product from obtaining any of the following specifications: EN55022 Class B, FCC Part 15J Class B

Safety

The display will not inhibit the end product from obtaining any of the following specifications: UL544, IEC 950

Optical

Determined at 70 Hz frame rate at room temperature.

Display Colour

Wide band amber (Zn:Mn)

Table 11. Optical Characteristics.

Areal Luminance		
On Luminance (typ)	C2 / C3	53 cd/m ² (16 fL)
	CD3	21 cd/m ² (6.4 fL)
On Luminance (min.)	C2 / C3	45 cd/m ² (13 fL)
	CD3	17 cd/m ² (5.0 fL)
Measured at the center and the four corners of the screen.		
Luminance Non-uniformity		
	35%	= (1 - min. luminance/max luminance) x 100. Maximum difference between any two of five points (center and four corners).
Luminance Variation (Time)		
Maximum	20%	10,000 h
Luminance Variation (Temperature)		
Typical	10%	over 0...+55°C range.
Maximum	15%	
Viewing Angle		
	>160°	

Illuminance	Classification
10 ... 100 lx	dim
100 ... 1000 lx	office
1000 ... 10000 lx	bright
10000 ... 100000 lx	sunlight

Optional Filter

The luminance contrast of the ICE version of the display EL640.400-CD3 is sufficient for operation without any contrast enhancement. An anti-reflective coating or protecting sheet with anti-reflective treatment is recommended. For best overall performance of EL640.400-C2 and -C3, a neutral gray circular polarizing filter with anti-reflective coating or etch is the usual choice. This filter will make the reflective electrodes of the display darker and will improve the contrast ratio. The anti-reflective coating on the filter should face the user.

Mechanical Characteristics

Display External Dimensions

Fig. 7 shows the mechanical dimensions of the standard EL640.400–C2, –C3 and –CD3 display unit. The display can also be delivered with optional FRA aluminium frames (see Fig. 7). See Ordering Information on page 23.

Table 12. Display External Dimensions.

Height	152.8 mm	6.02 in.
Width	225.8 mm	8.89 in.
Depth	16.5 mm	0.65 in.
Weight	400 g	14 oz.

Display Viewing Area Characteristics

Table 13. Display Viewing Area Characteristics.

Active Area millimeters (inches)	height	121.8 (4.80)
	width	195.0 (7.68)
Pixel Pitch millimeters (inches)	height	0.305 (0.012)
	width	0.305 (0.012)
Pixel Size millimeters (inches)	height	0.178 (0.007)
	width	0.212 (0.008)
Pixel fill factor	41%	
Pixel Matrix	640 horizontal by 400 vertical	

CAUTION: The ambient temperature of the display should not be allowed to exceed the environmental specifications (see Table 10). In most applications, an air gap of appr. 5 mm is recommended (see mechanical drawings). Some applications may require, however, a larger air gap or cooling of the display unit in the system. Note that this may slightly increase the total depth of the design.

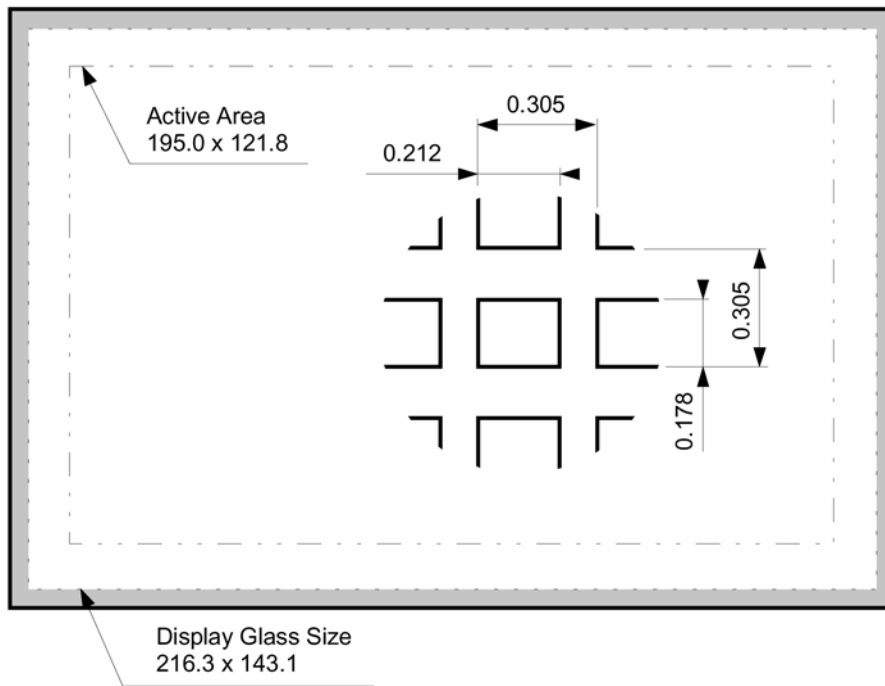
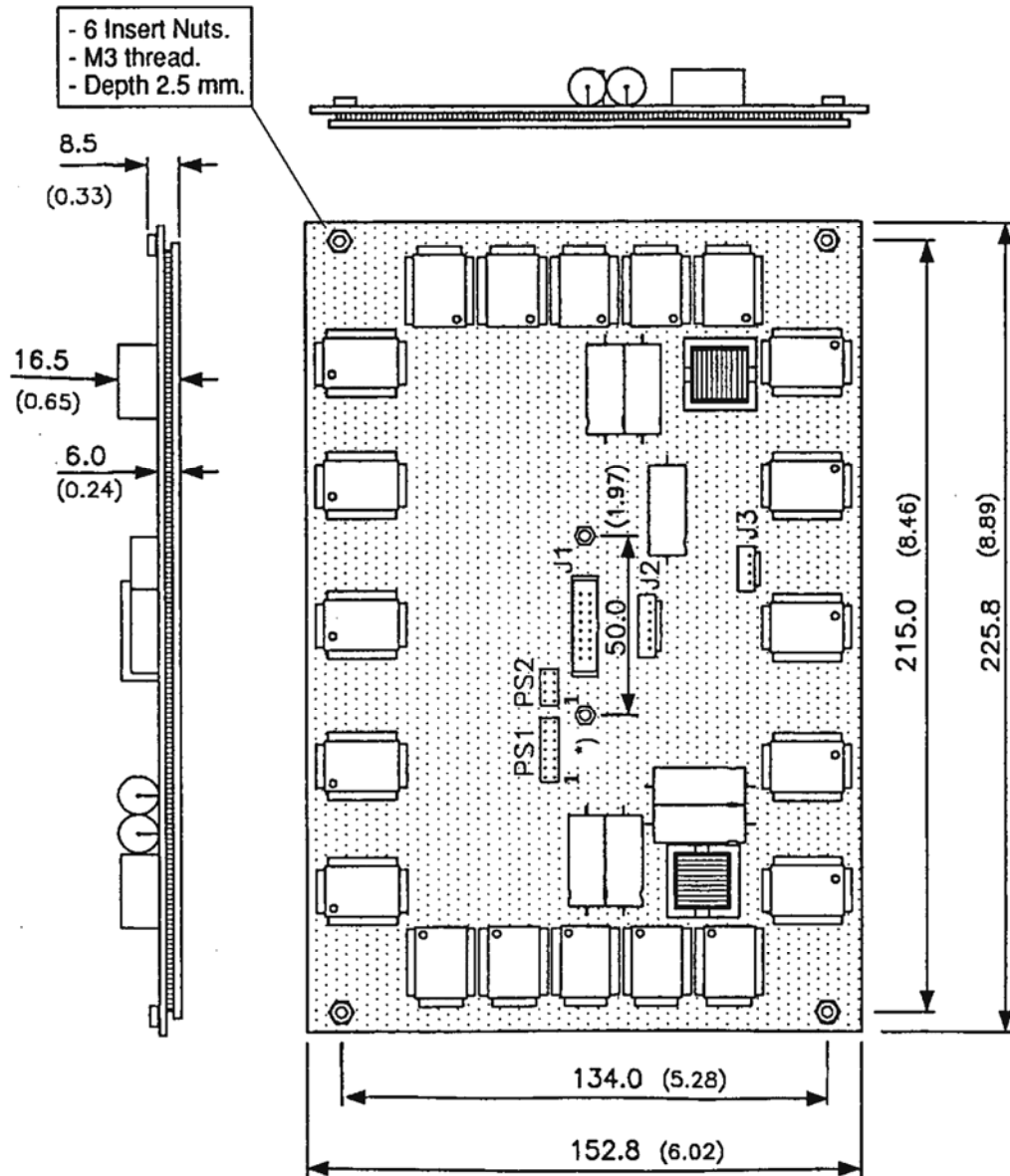

Fig 7. Viewing Area Characteristics.



26.84.98
DFC 40639 / 2

*) This Insert Nut is connected to System Ground.
Dimensions in mm (inches).

Fig 8. EL640.400-C2, -C3 and -CD3 Back and Side Views.
Dimensions in mm.

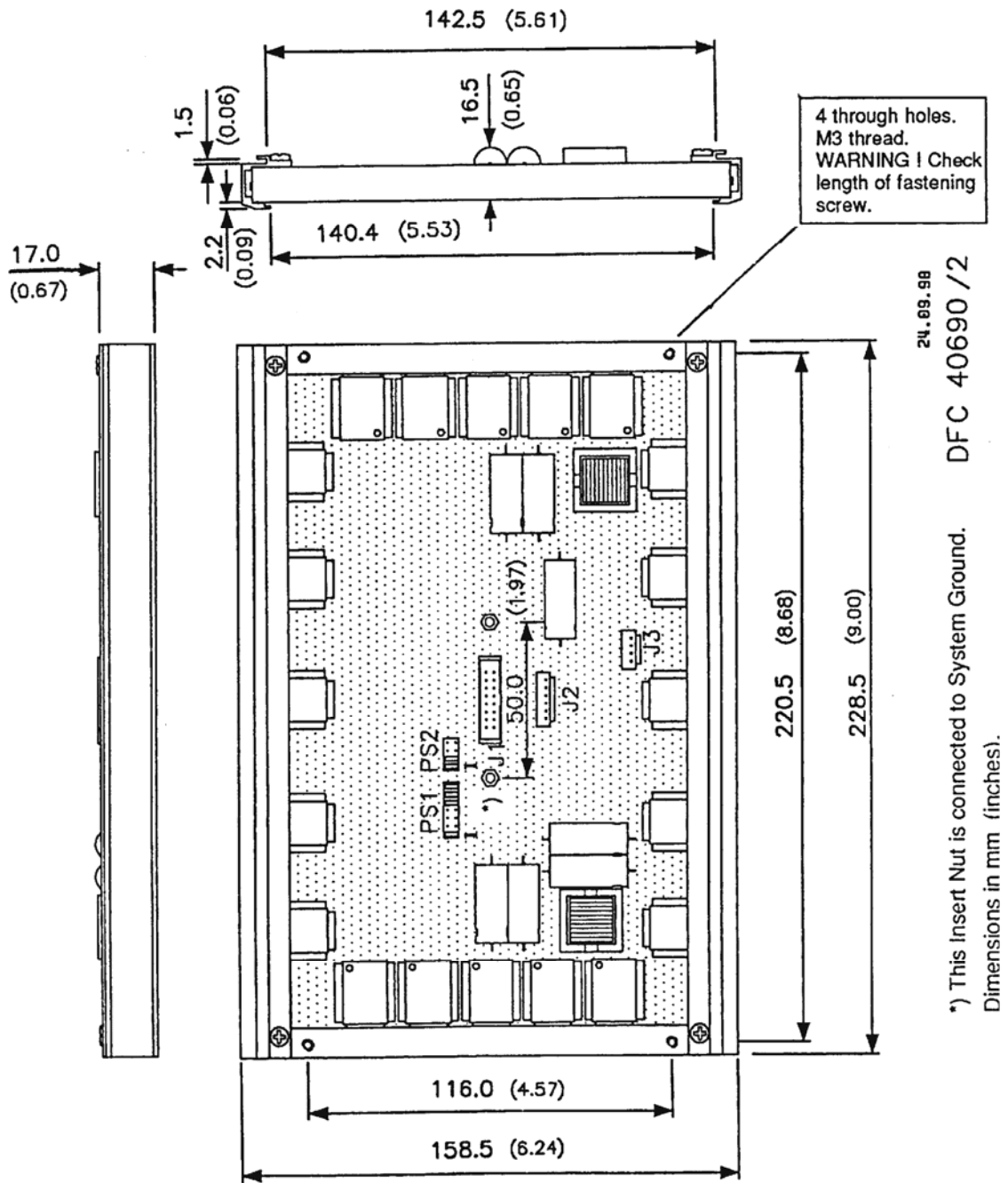

Fig 9. EL640.400-C2 FRA, -C3 FRA and -CD3 FRA Back and Side Views
Dimensions in mm.

Description of Warranty

Seller warrants that the Goods will conform to published specifications and be free from defects in material for 12 months from delivery. To the extent that Goods incorporate third-party-owned software, Seller shall pass on Seller's licensor's warranty to Buyer subject to the terms and conditions of Seller's license.

Warranty repairs shall be warranted for the remainder of the original warranty period. Buyer shall report defect claims in writing to Seller immediately upon discovery, and in any event, within the warranty period. Buyer must return Goods to Seller within 30 days of Seller's receipt of a warranty claim notice and only after receiving Seller's Return Goods Authorization. Seller shall, at its sole option, repair or replace the Goods.

If Goods were repaired, altered or modified by persons other than Seller, this warranty is void. Conditions resulting from normal wear and tear and Buyer's failure to properly store, install, operate, handle or maintain the Goods are not within this warranty. Repair or replacement of Goods is Seller's sole obligation and Buyer's exclusive remedy for all claims of defects. If that remedy is adjudicated insufficient, Seller shall refund Buyer's paid price for the Goods and have no other liability to Buyer.

All warranty repairs must be performed at Seller's authorized service center using parts approved by Seller. Buyer shall pay costs of sending Goods to Seller on a warranty claim and Seller shall pay costs of returning Goods to Buyer. The turnaround time on repairs will usually be 30 working days or less. Seller accepts no added liability for additional days for repair or replacement.

If Seller offers technical support relating to the Goods, such support shall neither modify the warranty nor create an obligation of Seller. Buyer is not relying on Seller's skill or judgment to select Goods for Buyer's purposes. Seller's software, if included with Goods, is sold as is, and this warranty is inapplicable to such software.

SELLER DISCLAIMS ALL OTHER WARRANTIES, EXPRESS OR IMPLIED, INCLUDING BUT NOT LIMITED TO, IMPLIED WARRANTIES OF MERCHANTABILITY AND FITNESS FOR A PARTICULAR PURPOSE.

Easy to Use

There are many options available which make Planar flat panel displays easy to use, easy to interface, and easy to package. Call Planar for complete information.

Support and Service

Planar is a US company based in Beaverton, Oregon and Espoo, Finland with a worldwide sales distribution network. Full application engineering support and service are available to make the integration of Planar displays as simple and quick as possible for our customers.

RMA Procedure: For a Returned Material Authorization number, please contact Planar Systems, Inc., with the model number(s) and original purchase order number(s). When returning goods for repair, please include a brief description of the problem, and mark the outside of the shipping container with the RMA number.

Ordering Information

Product	Part Number	Description
EL640.400-C2	E0064440101	EL640.400 non-ICE, dimming, 0 - +55° C
EL640.400-C2 FRA	E0064440122	EL640.400-C2 with aluminum mounting frame
EL640.400-C3	996-5056-00	EL640.400 non-ICE, dimming, -25 - +65° C
EL640.400-C3 FRA	996-5062-00	EL640.400-C3 with aluminum mounting frame
EL640.400-CD3-FRA	996-5082-01	EL640.400-C3 with ICE and aluminum mounting frame

Design and Specifications subject to change without notice.

Planar Systems, Inc.

Customer Service

24x7 Online Technical Support: <http://www.planar.com/support>

Americas Support

1195 NW Compton Drive

Beaverton, OR 97006-1992

Tel: 1-866-PLANAR1 (866) 752-6271

Hours: M-F, 5am - 5pm Pacific Time

Europe and Asia-Pacific Support

Olarinluoma 9 P.O. Box 46

FIN-02201 Espoo, Finland

Tel: +358-9-420-01

Hours: M-F, 7:00am - 4pm CET

© 2004 **Planar Systems, Inc. 06/04** Planar is a registered trademark of Planar Systems, Inc.

ICE, ICEBrite, and ICEPlus are trademarks of Planar Systems, Inc.

Other brands and names are the property of their respective owners.

Technical information in this document is subject to change without notice.

020-0355-00A